



PDS_445

HDPE ROTOMOULDED SLIDE 'OPTIMA' - 1500



MANUAL : M445
SALESSTATUS : STD
PRODUCT DIMENSIONS : 2800 x 495 x 320

MATERIAL :



EN rotomoulded slide 'Optima'

- attachment slide
- platform height: 1500 mm
- to be fixed at the platform and at the bottom with bolts (not supplied)

NL rotatiegevormde glijbaan HDPE 'Optima'

- aanbouwglijbaan
- platformhoogte 1500 mm
- op het platform en onderaan te bevestigen met bouten (worden niet meegeleverd)

FR glissière en PEHD rotomoulé 'Optima'

- à attacher
- pour plate-forme de 1500 mm
- à attacher à la plate-forme et en bas avec des boulons (ne sont pas fournis)

DE HDPE Rutsche Rotationsverfahren 'Optima'

- Anbaurutsche
- Podesthöhe von 1500 mm
- oben an der Plattform sowie unten zu befestigen mit Schrauben (werden nicht mitgeliefert)

ES tobogán de HDPE rotomoldeado 'Optima'

- a sujetar
- para plataforma de 1500 mm
- anchura de ajuste 600 mm
- a fijar en plataforma y en la parte inferior con pernos (no suministrados)

PL zjeżdżalnia HDPE typu 'Optima'

- zjeżdżalnia mocowana
- wysokość platformy: 1500 mm
- montowana śrubami do platformy i przy nawierzchni (nieobjęte dostawą)

PACKAGING

h: 1500mm	22,4 kg	1	280 x 50 x 43 cm	23 kg
h: 1500mm	22	110 x 300 x 220 cm	490 kg	



KBT nv
Hemelrijken 8
2890 Sint-Amands
Belgium





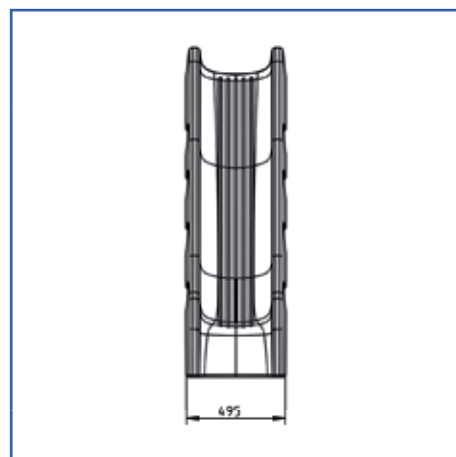
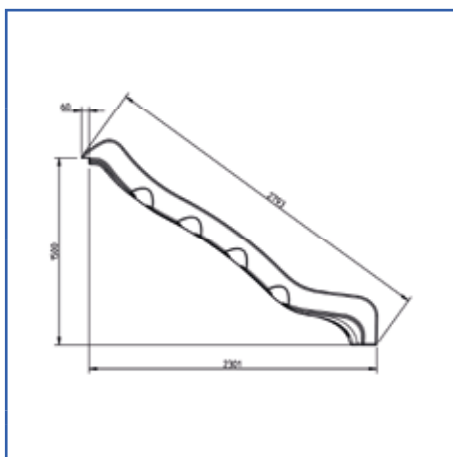

KBT Polska sp. z o.o.
ul. M. Konopnickiej 6
00-491 Warszawa
Poland

HDPE ROTOMOULDED SLIDE 'OPTIMA' - 1500

DRAWINGS:



VARIATIONS :

	445.015.001.001	HDPE rotomoulded slide - 'optima' - h: 1500 - red
	445.015.002.001	HDPE rotomoulded slide - 'optima' - h: 1500 - green
	445.015.003.001	HDPE rotomoulded slide - 'optima' - h: 1500 - yellow
	445.015.004.001	HDPE rotomoulded slide - 'optima' - h: 1500 - blue
	445.015.005.001	HDPE rotomoulded slide - 'optima' - h: 1500 - lime green
	445.015.015.001	HDPE rotomoulded slide - 'optima' - h: 1500 - anthracite RAL 7016